

SONOFF

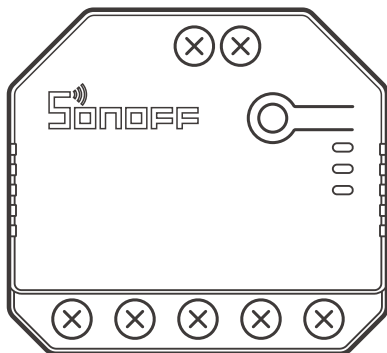

DIY DUALR3

User manual V1.0



2-Gang Wi-Fi Smart Switch

Operating Instruction

1. Power off

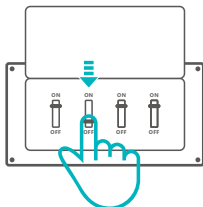

⚠ To avoid electric shocks, please consult the dealer or a qualified professional for help when installing and repairing! Please do not touch the switch during use.

2. Wiring instruction

Motor mode:

① Momentary switch:

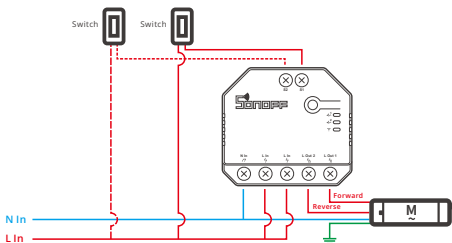

⚠ Connect to S1 or S2 for smart control of connected devices; connect to S1 and S2 for two-way smart control.

② Dual relay momentary switch/3-gang rocker switch:

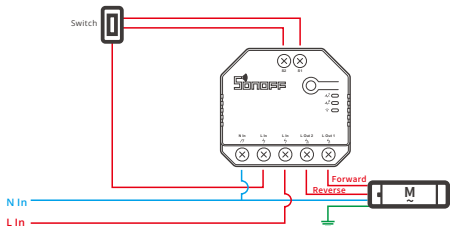

Light fixture wiring instruction:

- ① To enable dual relay control, S1 and S2 are required to connect the push button switch in the pulse mode or the rocker light switch in the edge mode:

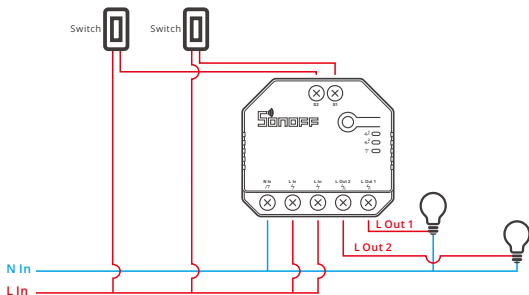

- ② Connect SPDT switches in the edge mode to reach double two-way control:

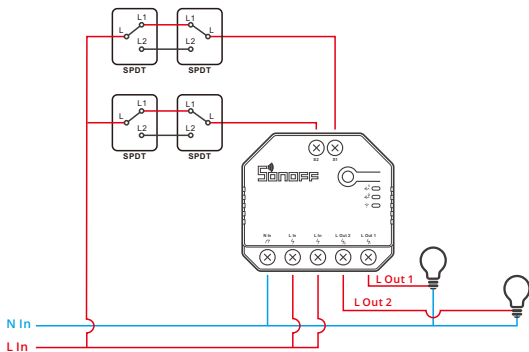

③ Connect dry contact sensors in the following mode:

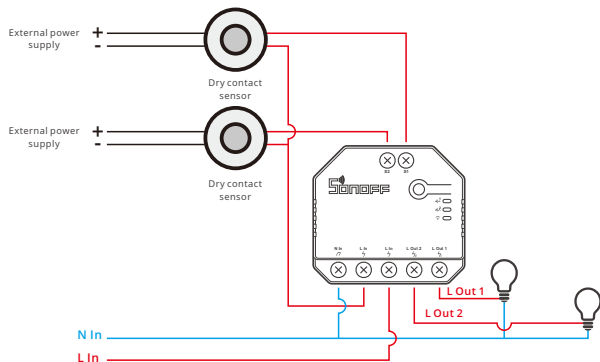

- ⚠ Make sure the neutral wire and live wire connection is correct.
- ⚠ The device still works normally if no a physical light switch is connected to S1/S2.
- ⚠ If S1/S2 is connected to a physical light switch, the corresponding working mode is required in eWeLink APP to select for normal use.

3. Download the eWeLink APP



Android™ & iOS

4. Power on

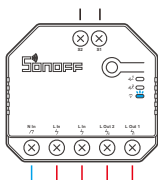

After powering on, the device will enter the bluetooth pairing mode during the first use. The Wi-Fi LED indicator changes in a cycle of two short and one long flash and release.

⚠ The device will exit the bluetooth pairing mode if not paired within 3mins. If you want to enter this mode, please long press the manual button for about 5s until the Wi-Fi LED indicator changes in a cycle of two short and one long flash and release.

5. Add the device



Tap "+" and select "bluetooth pairing", then operate following the prompt on the APP.

Specifications

Model	DUALR3
Input	100-240V AC 50/60Hz 15A Max
Output	100-240V AC 50/60Hz
Resistive Load	2200W/10A/Gang 3300W/15A/Total
Motor Load	10-240W/1A
Wi-Fi	IEEE 802.11 b/g/n 2.4GHz
Operating systems	Android & iOS
Number of gangs	2-Gang
Working temperature	-10°C~40°C
Material	PC V0
Dimension	54x49x24mm

Product Introduction

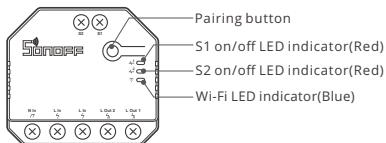

ⓘ The device weight is less than 1 kg. The installation height of less than 2 m is recommended.

Wi-Fi LED indicator status instruction

LED indicator status	Status instruction
Flashes (one long and two short)	Bluetooth Pairing Mode
Keeps on	Device is connected successfully
Flashes quickly	Compatible Pairing Mode
Flashes quickly once	Unable to discover the router
Flashes quickly twice	Connect to the router but fail to connect to server
Flashes quickly three times	Upgrading

Working Mode

After pairing, select the corresponding mode from switch, motor and meter modes according to the connected device. Please check the detailed instruction for working modes on eWeLink app.

Features

This device is a Wi-Fi smart switch with power monitoring that allows you to remotely turn on/off the device, schedule it on/off or share it with your family to control together.



Remote Control



Single/Countdown
Timing



Share Control



Smart Scene



Sync Status



Power Monitoring



Over-load
Protection



Inching Mode



Power-on State



LAN Control

Switch Network

If you need to change the network, long press the pairing button for 5s until the Wi-Fi LED indicator changes in a cycle of two short and one long flash and release, then the device enters Bluetooth pairing mode and you can pair again.

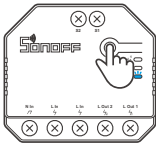

Factory Reset

Deleting the device on the eWeLink app indicates you restore it to factory setting.

Common Problems

Q: Why my device stays "Offline"?

A: The newly added device needs 1 – 2mins to connect Wi-Fi and network. If it stays offline for a long time, please judge these problems by the blue Wi-Fi indicator status:

1. The blue Wi-Fi indicator quickly flashes once per 2 seconds, which means that the switch failed to connect your Wi-Fi:
 - ① Maybe you have entered a wrong Wi-Fi password.
 - ② Maybe there's too much distance between the switch your router or the environment causes interference, consider getting close to the router. If failed, please add it again.
 - ③ The 5G Wi-Fi network is not supported and only supports the 2.4GHz wireless network.
 - ④ Maybe the MAC address filtering is open. Please turn it off.

If none of the above methods solved the problem, you can open the mobile datanetwork on your phone to create a Wi-Fi hotspot, then add the device again.

2. Blue indicator quickly flashes twice per 2 seconds, which means your device has connected to Wi-Fi but failed to connect to the server.

Ensure steady enough network. If double flash occurs frequently, which means you access an unsteady network, not a product problem. If thenetwork is normal, try to turn off the power to restart the switch.

The full text of the EU declaration of conformity is available at the following internet address: <https://sonoff.tech/usermanuals>