

DONEXON

varmo TZ eco

SKU: DONEVARMOTZEKO



Quickstart

This is a **secure HVAC-Thermostat** for **Europe**. To run this device please insert fresh **2 * AA 1,5V** batteries. Please make sure the internal battery is fully charged.

1. Start Inclusion mode of your primary Z-Wave Controller.
2. Press the Boost-Button.varmo TZ eco will show the assigned Node ID.

Important safety information

Please read this manual carefully. Failure to follow the recommendations in this manual may be dangerous or may violate the law. The manufacturer, importer, distributor and seller shall not be liable for any loss or damage resulting from failure to comply with the instructions in this manual or any other material. Use this equipment only for its intended purpose. Follow the disposal instructions. Do not dispose of electronic equipment or batteries in a fire or near open heat sources.

What is Z-Wave?

Z-Wave is the international wireless protocol for communication in the Smart Home. This device is suited for use in the region mentioned in the Quickstart section.

Z-Wave ensures a reliable communication by reconfirming every message (**two-way communication**) and every mains powered node can act as a repeater for other nodes (**meshed network**) in case the receiver is not in direct wireless range of the transmitter.

This device and every other certified Z-Wave device can be **used together with any other certified Z-Wave device regardless of brand and origin** as long as both are suited for the same frequency range.

If a device supports **secure communication** it will communicate with other devices secure as long as this device provides the same or a higher level of security. Otherwise it will automatically turn into a lower level of security to maintain backward compatibility.

For more information about Z-Wave technology, devices, white papers etc. please refer to www.z-wave.info.



Product Description

The varmo TZ eco radiator valve regulates your radiator with energy-saving Z-Wave wireless standard. Thus, you can add a component to your Z-Wave Smart Home network.Thanks to the FLiRS (Frequently Listening Receiver Slave), the heating valve responds to incoming commands without any major delays, for example changing the temperature.Design covers are available in various colors, so you can change them according to your wishes and interior design.The varmo TZ eco radiator valve is easy to operate, has an orange backlit display and an extra large temperature display. Heating periods are programmable, the daily and weekly times are individually programmable and the valve detects when a window is open. The manual adjustment is of course possible at any time.In addition, the valve has a child safety lock and various security levels, a frost and lime protection function and fits on many common radiator valves.The display can be rotated 180 degrees.

Prepare for Installation / Reset

Please read the user manual before installing the product.

In order to include (add) a Z-Wave device to a network it **must be in factory default state**. Please make sure to reset the device into factory default. You can do this by performing an Exclusion operation as described below in the manual. Every Z-Wave controller is able to perform this operation however it is recommended to use the primary controller of the previous network to make sure the very device is excluded properly from this network.

Reset to factory default

This device also allows to be reset without any involvement of a Z-Wave controller. This procedure should only be used when the primary controller is inoperable.

Remove batteries. Press and hold boost button. While still holding boost button insert batteries. The LCD shows RES. Release boost button. To perform the factory reset press boost button.

Safety Warning for Batteries

The product contains batteries. Please remove the batteries when the device is not used. Do not mix batteries of different charging level or different brands.

Installation

Mounting the Donexon TZ eco Thermostat

After adding the Donexon TZ eco Thermostat to a network, it is ready to be installed on the radiator. The LCD shows INS. Do not press the boost button yet.

Installation at the radiator without Adapter

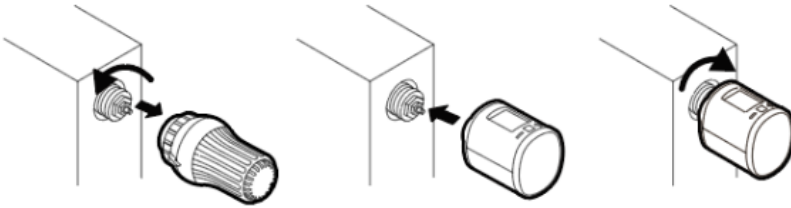

Installation at the radiator with Adapter

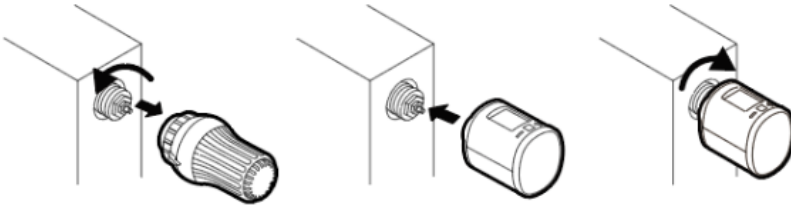

Mechanical Installation

Press the boost button to start mechanical installation.

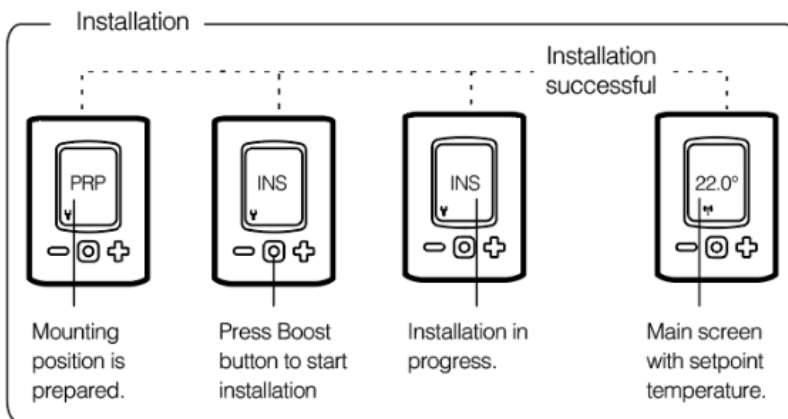

Unmounting the Donexon TZ eco Thermostat

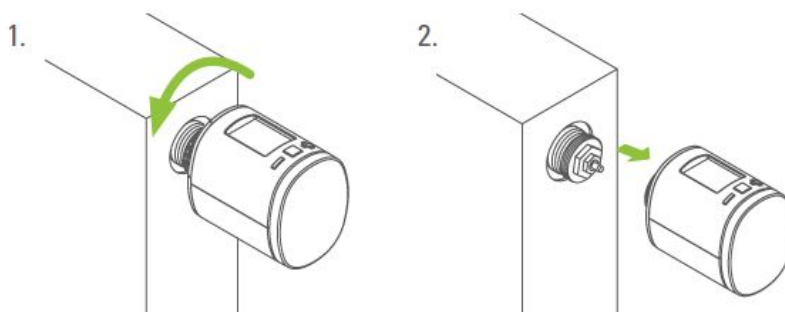

Inclusion/Exclusion

On factory default the device does not belong to any Z-Wave network. The device needs to be **added to an existing wireless network** to communicate with the devices of this network. This process is called **Inclusion**.

Devices can also be removed from a network. This process is called **Exclusion**. Both processes are initiated by the primary controller of the Z-Wave network. This controller is turned into exclusion respective inclusion mode. Inclusion and Exclusion is then performed doing a special manual action right on the device.

Inclusion

Press the Boost-Button. varmo TZ eco will show the assigned Node ID.

Exclusion

Press and hold the boost button of the varmo TZ eco for at least 5 seconds.

Product Usage





Buttons:



Button	Interaction	Result/Behavior
—	Press once	Decrease room temperature by 0,5°C
—	Press and hold	Decrease room temperature by 0,5°C lower every 0,5 seconds or until the lowest temperature is set
+	Press once	Increase room temperature by 0,5°C
+	Press and hold	Increase room temperature by 0,5°C and raise every 0,5 seconds or until the highest temperature is set
○	Push once	<ul style="list-style-type: none"> - Confirm action which is displayed in the LED - Switch in the Boost mode (Quick Heat) - Quit Boost mode, if currently active
○	Hold for 3 seconds	The LCD shows Z-Wave Node ID
○	Hold for 5 seconds	Exclusion Mode
○	Hold while unpowered and insert batteries	Factory Reset
+ —	Hold both simultaneously for 3 seconds	Sets or clear child protection

Boost-Taste Led's



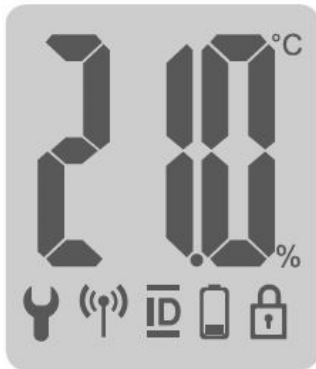

Color	State	Meaning
	Blinking	OTA Update is in process
	Lights constantly for 5 seconds	A task has failed
	Permanently on	An error occurred
	Blinking	User conformation is required to start a task
	Lights constantly for 5 seconds	A task was completed successfully

LCD





 **Wrench:** Lights up if mechanical tasks are ongoing

 **Antenna:**
Displays the Radiator Thermostat network state.
Segment visible: rf-link established
Segment turnoff: rf-link lost

 **ID:** Lights up if the Display shows the Z-Wave NodeID

 **Battery:** Lights up if less than 15% battery is remaining

 **Lock:** Light up if child protection is set

 **Degree Celsius:** Displayed if the LCD shows a setpoint temperature

Inserting batteries

Remove the battery cover by simply pulling it off. Now insert the batteries. Pay attention to the correct polarity! At a later battery change, the configuration of your Donexon TZ eco Thermostat is maintained.



Setpoint adjustment

The setpoint is adjusted via plus and minus button.
Altering the setpoint locally will set the Donexon TZ eco Thermostat in heating mode.
The energy saving setpoint can only be adjusted via Z-Wave.
The configurable setpoint range is 8°C to 28°C.
If the setpoint is increased/decreased above/below the set point limits, the Donexon TZ eco Thermostat will change into boost / off mode.

Child protection

Press and hold plus and minus button simultaneously for 3 seconds to enable/disable the child protection.
If the Donexon TZ eco Thermostat is set into the highest protection level it is no longer possible to operate the device locally.

Altering the operating states

Off-Mode

Press minus button until OFF is displayed.

Boost-Mode

Push the boost button.
Alternatively, press the plus button until ON is displayed.

Heating-Mode

If the operating state is not heating mode, pressing the plus or

minus button will bring the device in heating mode.

Window open detection

If the room temperature drops, the window open detection will trigger. Donexon TZ eco Thermostat will change temporarily in off mode for 15 minutes. Window open detection will end automatically after 15 minutes and the previously active operating mode will be restored. Window open detection can also be canceled by a button press. The window open detection is disabled during manufacturer specific mode. The sensitivity of the window open detection can be configured

Display NodeID

Press and hold the boost button for 3 seconds to display the NodeID.

Quick trouble shooting

Here are a few hints for network installation if things dont work as expected.

1. Make sure a device is in factory reset state before including. In doubt exclude before include.
2. If inclusion still fails, check if both devices use the same frequency.
3. Remove all dead devices from associations. Otherwise you will see severe delays.
4. Never use sleeping battery devices without a central controller.
5. Dont poll FLIRS devices.
6. Make sure to have enough mains powered device to benefit from the meshing

Association - one device controls an other device

Z-Wave devices control other Z-Wave devices. The relationship between one device controlling another device is called association. In order to control a different device, the controlling device needs to maintain a list of devices that will receive controlling commands. These lists are called association groups and they are always related to certain events (e.g. button pressed, sensor triggers, ...). In case the event happens all devices stored in the respective association group will receive the same wireless command wireless command, typically a 'Basic Set' Command.

Association Groups:

Group Number	Maximum Nodes	Description
1	1	Z-Wave Plus Lifeline

Configuration Parameters

Z-Wave products are supposed to work out of the box after inclusion, however certain configuration can adapt the function better to user needs or unlock further enhanced features.

IMPORTANT: Controllers may only allow configuring signed values. In order to set values in the range 128 ... 255 the value sent in the application shall be the desired value minus 256. For example: To set a parameter to 200 it may be needed to set a value of 200 minus 256 = minus 56. In case of a two byte value the same logic applies: Values greater than 32768 may needed to be given as negative values too.

Parameter 1: LCD invert

Size: 1 Byte, Default Value: 0

Setting	Description
0	Normal orientation
1	LCD content inverted

Parameter 2: LCD Timeout

Size: 1 Byte, Default Value: 0

Setting	Description
0	LCD always on
5 - 30	LCD timeout in seconds

Parameter 3: Backlight

Size: 1 Byte, Default Value: 1

Setting	Description
0	Backlight disabled
1	Backlight enabled

Parameter 4: Battery report

Size: 1 Byte, Default Value: 1

Setting	Description
0	Battery reporting disabled
1	Battery reporting enabled

Parameter 5: Measured temperature report

Size: 1 Byte, Default Value: 5

Setting	Description
0	Reporting disabled
1 - 50	Reporting Delta in 1/10 Celcius

Parameter 6: Valve percentage report

Size: 1 Byte, Default Value: 0

Setting	Description
0	Reporting disabled
1 - 100	Reporting Delta in percent

Parameter 7: Window open detection

Size: 1 Byte, Default Value: 2

Setting	Description
0	Detection disabled
1 - 3	Sensitivity level

Parameter 8: Measured temperature offset

Size: 1 Byte, Default Value: 0

Setting	Description
-50 - 50	Offset in 1/10 Celcius
-128 - 0	Temperature is supplied externaly

Technical Data

Dimensions	56x68x89 mm
Weight	128 gr
Hardware Platform	ZM5202
EAN	4251660900025
IP Class	IP 20
Battery Type	2 * AA 1,5V
Device Type	Thermostat - HVAC
Network Operation	Listening Sleeping Slave
Z-Wave Version	6.71.01
Certification ID	ZC10-19056474
Z-Wave Product Id	0x0148.0x0003.0x0004
Thermostat Modes	Energy Save HeatHeat
Firmware Updatable	Updatable by Consumer by RF
Sensors	Air Temperature
Supported Notification Types	Power ManagementSystem
Thermostat HVAC Systems Supported	Heat Only
Frequency	Europe - 868,4 Mhz
Maximum transmission power	5 mW

Supported Command Classes

- Association Grp Info
- Association V2
- Basic
- Battery
- Configuration
- Device Reset Locally
- Firmware Update Md V3
- Manufacturer Specific
- Notification V8
- Powerlevel
- Protection
- Security
- Security 2
- Sensor Multilevel V5
- Supervision
- Switch Multilevel
- Thermostat Mode V3
- Thermostat Setpoint V3
- Transport Service V2
- Version V2
- Zwaveplus Info V2

Explanation of Z-Wave specific terms

- **Controller** — is a Z-Wave device with capabilities to manage the network. Controllers are typically Gateways, Remote Controls or battery operated wall controllers.
- **Slave** — is a Z-Wave device without capabilities to manage the network. Slaves can be sensors, actuators and even remote controls.
- **Primary Controller** — is the central organizer of the network. It must be a controller. There can be only one primary controller in a Z-Wave network.
- **Inclusion** — is the process of adding new Z-Wave devices into a network.
- **Exclusion** — is the process of removing Z-Wave devices from the network.
- **Association** — is a control relationship between a controlling device and a controlled device.
- **Wakeup Notification** — is a special wireless message issued by a Z-Wave device to announces that is able to communicate.
- **Node Information Frame** — is a special wireless message issued by a Z-Wave device to announce its capabilities and functions.